

Centrifugal Fans - Series 21 & 41 Model CSW

- Backward-Inclined and Airfoil Wheels
- Single-Width



*Commercial &
Industrial Applications*

 **GREENHECK**
Building Value in Air.



BUILDING VALUE IN AIR.

January
2014

Greenheck's airfoil and backward-inclined centrifugal fans are designed to provide efficient and reliable operation for commercial and industrial applications. Our products are manufactured with state-of-the-art laser, forming, spinning and welding equipment, and endure our quality control testing to ensure trouble-free start-up. Greenheck centrifugal models include industry-leading design features to ensure your ventilation equipment has the latest technologies available.

Available with Greenheck Centrifugal Products:

- AMCA Licensed Sound and Air Performance
- Permalock™ or all welded scroll design
- Concentric mount bearings with industries highest cataloged bearing life
- Corrosion-resistant, electrostatically applied and baked powder coatings
- Both belt and direct drive configurations
- Three-plane, six-channel vibration analysis on all manufactured centrifugal models



Greenheck Fan Corporation certifies that the CSW backward-inclined and airfoil centrifugal fans shown herein are licensed to bear the AMCA Seal. The ratings shown are based on tests and procedures performed in accordance with AMCA Publication 211 and Publication 311 and comply with the requirements of the AMCA Certified Ratings Program. AMCA Licensed Sound and Air Performance can be found in Greenheck Fan Corporation Supplement:
CSW Performance 00.CVI.1030 R1 7-2013



UL/cUL File #E40001
UL/cUL 705 Listed Power Ventilator
US LISTED



Series 21 Permalock™ Housings

Series 21 or Permalock™ housings use a mechanically fastened seam instead of welding. This airtight and watertight housing construction uses the same structural support as all welded Series 41 housings. Permalock construction is an excellent value engineering option for applications up to 8.5 inches wg (2.1 kPa).

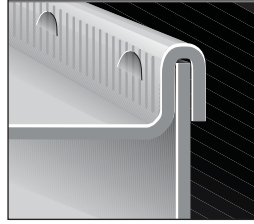

Series 41 Welded Housings

Greenheck Series 41 centrifugal fans are manufactured with heavy gauge, welded housing construction. All welded Series 41 construction is common for industrial applications and is suitable for pressures up to 22 in. wg (5.5 kPa). Alternative housing materials such as aluminum or stainless steel are only available with Series 41 construction.



	Size	Class	Housing Material	Wheel Type	Arrangements
Series 21	33–49	0, I, II	Steel	Backward-Inclined or Airfoil	1, 3, 9, or 10
Series 41	33–73	0, I, II, III, IV	Steel, Aluminum, Stainless Steel		1, 3, 4, 8, 9 or 10

Standard Construction Features

Housings are manufactured of laser cut and formed steel. Drive frames are manufactured with heavy-gauge, welded steel. Aluminum or stainless steel construction is optional.

Fan shafts are turned and polished steel that is sized so the first critical speed is at least 25% over the maximum operating speed.

Adjustable motor plate for easy belt tensioning. Available on arrangements 9 and 10.

Steel housings and **wheels** are coated with Permatecor™, an electrostatically applied and baked polyester urethane. Permatecor™ is an excellent coating for interior or exterior applications. Greenheck offers a wide variety of additional protective coatings. Consult Greenheck’s Product Application Guide, [Performance Coatings for Ventilation Products](#) for a complete listing of coatings and a relative resistance chart.



Example shown is Model CSW Arrangement 9

Wheels

Greenheck centrifugal fans have non-overloading backward-inclined blades. Both our Backward-Inclined (BI) and Airfoil (AF) designs operate efficiently and quietly in single-width configurations. All wheels are statically and dynamically balanced to grade G6.3 per ANSI S2.19.

	CSW-BI	CSW-AF
Wheel Type		
Application	General purpose, clean air or severe environments	Clean air or fume exhaust
Temperature	Up to 1000°F (538°C)	Up to 500°F (260°C)
Construction	Steel Aluminum 316 Stainless Steel	Steel Aluminum

Premium Bearings

The BI and AF series of centrifugal products are manufactured with “Air Handling Quality” self-aligning ball or roller pillow block bearings. Our standard bearings use concentric lock collars (no set screws) which ensure smooth operation and provide superior grip force between the bearing collar and fan shaft. All bearings are selected for a basic rating fatigue life of L_{10} in excess of 80,000 hours (L_{50} at 400,000 hrs.) at the maximum RPM. For more critical applications, Greenheck offers bearings with a minimum L_{10} life in excess of 200,000 hours (L_{50} at 1,000,000 hrs.). Our bearings include zerk fittings for relubrication.



	L_{10} Life	Equal to L_{50} or Average Life
Industry Standard	40,000 hrs.	200,000 hrs.
Greenheck Standard	80,000 hrs.	400,000 hrs.
Greenheck Upgrade	200,000 hrs.	1,000,000 hrs.

L_{10} life implies 90% reliability or 10% failure rate after the stated hours.
 L_{50} life implies 50% reliability or 50% failure rate after the stated hours.

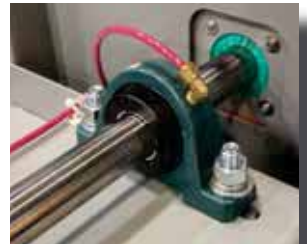

Vibration Analysis

All Greenheck centrifugal products endure a complete mechanical vibration test after assembly. Our custom data acquisition system uses tri-axial accelerometers to measure the vibration in three planes at the design operating speed. A permanent record for each fan's performance is kept on file and is available upon request.

The standard “filter-in” vibration levels attained meet the requirements of Fan Application BV-3 as defined in AMCA Standard 204-05 “Balance Quality and Vibration Levels for Fans”. Consult factory if more stringent vibration levels are necessary.



Arrangement	Filter-In Vibration Limit (Rigidly Mounted)
1, 3, 9, 10, 8	0.15 in/sec-pk
4	0.08 in/sec-pk

Arrangement 10 — Belt Drive

Single-Width Backward Inclined or Airfoil Wheel

- Recommended as first choice configuration for belt drive applications.
- Bearings are mounted out of the airstream.
- Motor is mounted beneath the drive frame.
- Available with a weatherhood to cover motor, drives and bearings.
- Moderate dirt and heat tolerance.
- Compact design.
- Available with heat fan packages up to 500°F (260°C).

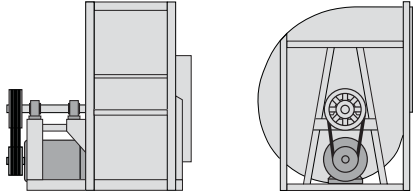

Class 0, I, II

Arrangement 9 — Belt Drive

Single-Width Backward Inclined or Airfoil Wheel

- Bearings are mounted out of the airstream.
- Easy access to large motors mounted on drive frame.
- Standard motor position is on the right side of the drive frame.
- Optional motor position is on the left side of the drive frame.
- Available with motor cover, belt guard and shaft guard.
- Available heat fan packages to 500°F (260°C).

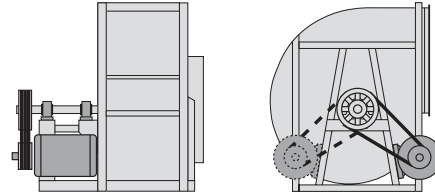

Class 0, I, II, III

Arrangement 1 — Belt Drive

*Single-Width Backward Inclined or *Airfoil Wheel*

- Bearings are mounted out of the airstream.
 - Unlimited motor size.
 - Requires an isolation base (by factory) or structural pad to mount the fan and motor.
 - Choice of motor positions W, X/Y or Z (see page 7).
 - Available with motor cover.
 - Suitable for high temperatures or contaminated air.
 - Available heat fan packages to 1000°F (538°C).
- [*Airfoil wheel available to 500°F (260°C)].

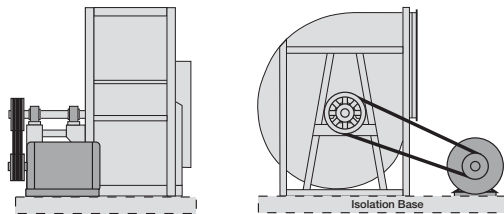

Class 0, I, II, III, IV

Arrangement 3 — Belt Drive

Single & Double-Width Backward Inclined or Airfoil Wheel

- Bearings are mounted in the airstream.
- Unlimited motor size.
- Requires an isolation base (by factory) or structural pad to mount the fan and motor.
- Choice of motor positions W, X/Y or Z (see page 7).
- Available with motor cover, belt guard.
- Recommended for clean air at ambient temperatures.

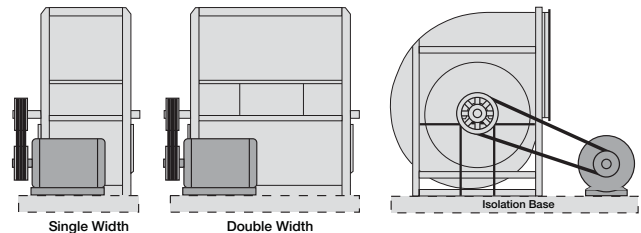

Class 0, I, II, III

Arrangement 4 — Direct Drive

Single-Width Backward Inclined or Airfoil Wheel

- Available with partial width wheel and housing modifications for specific performance.
- Recommended for higher horsepower applications in lieu of belt drive.
- Limited to standard motor speeds, but are available with variable frequency drive compatible motors.
- Provides compact design with low maintenance.
- Available with motor cover.

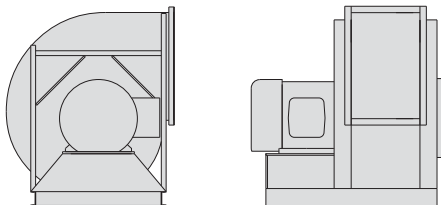

Class 0, I, II, III, IV

Arrangement 8 — Direct Drive

*Single-Width Backward Inclined or *Airfoil Wheel*

- Available with partial width wheel and housing modifications for specific performance.
 - Recommended for higher horsepower applications in lieu of belt drive.
 - Limited to standard motor speeds, but are available with variable frequency drive compatible motors.
 - Bearings located out of the airstream.
 - Suitable for high temperatures or contaminated air.
 - Available with motor cover, belt guard.
 - Available heat fan packages to 750°F (400°C).
- [*Airfoil wheel available to 500°F (260°C)].

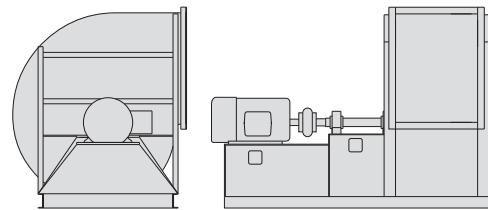

Class 0, I, II, III, IV

Discharge Positions and Rotatable Housings

All centrifugal fans are available with clockwise (CW) or counterclockwise (CCW) rotation in all standard discharge positions. **Rotation and discharge is always determined from the drive side of the fan.** Rotatable housings are standard on single-width fan sizes 30 and less; arrangements 1, 9 and 10; and Class 0, I and II.

Top Angular Down (TAD) and Bottom Angular Down (BAD) discharge positions are only available with special construction to prevent interference between the drive frame and fan discharge.

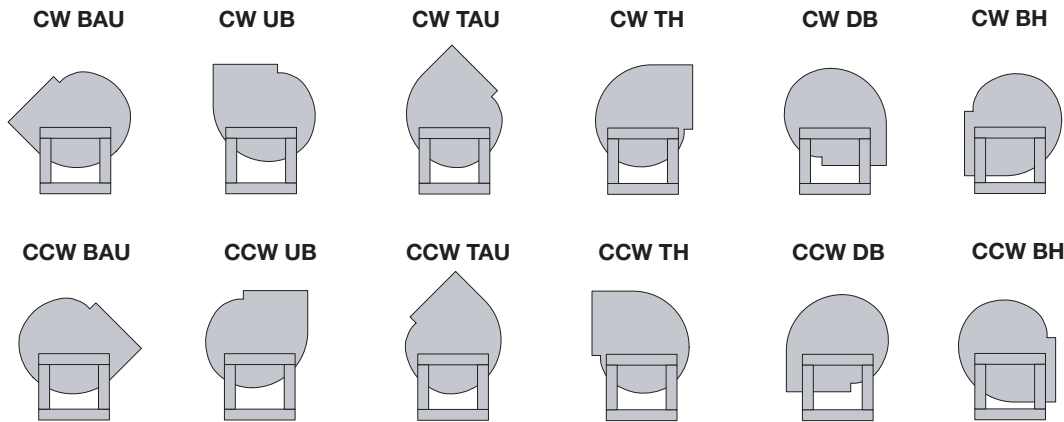

Motor Positions – Arrangements 1 and 3 Fans

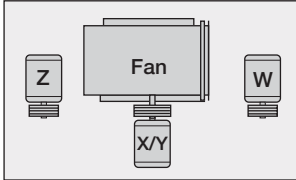

Motor position and fan rotation are determined from drive side

Fan arrangements 1 and 3 require a structural steel base or structural platform to support the fan and motor. The motor can be located in any of three positions around the fan shaft to ensure proper alignment. Motor positions W and Z tend to make a longer footprint from end to end. Positions X/Y tend to make a shorter but wider footprint.

Class of Construction

Fan class refers to a construction level designed to handle a given fan outlet velocity and pressure. As the fan performance requirements increase, the fan construction (material gauge, shaft diameter, motor size) must also increase to physically handle the new work load.

Centrifugal products are available in Class 0, I, II, III, or IV, with Class 0 being the lightest construction and Class IV having the heaviest construction and performance capacity.

A typical fan curve is shown with shaded class limits. Visit www.greenheck.com for complete centrifugal fan performance.

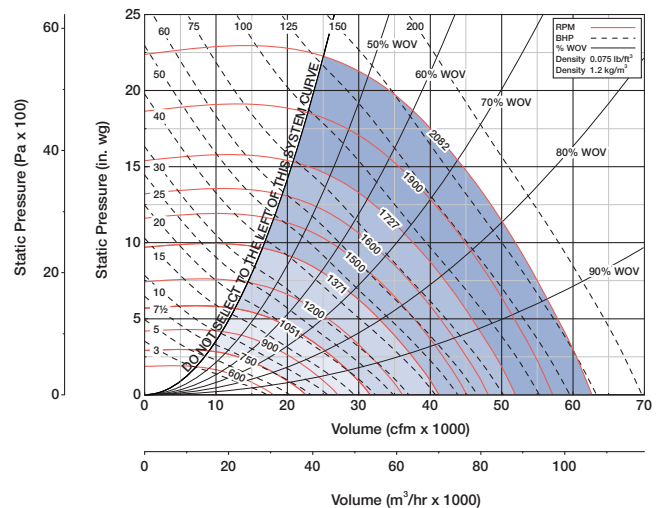

Class 0	Class I	Class II	Class III	Class IV
---------	---------	----------	-----------	----------

Alternative Materials

Greenheck offers all centrifugal models in aluminum or stainless construction as an alternative to coated steel. Aluminum construction provides advantages for applications with high moisture and various chemicals. Aluminum also reduces the weight of the fan if there are structural concerns. Stainless steel (316L) construction is used for environments subject to continuous high heat up to 1000°F (538°C) or severe corrosives. Both aluminum or stainless steel construction can be applied to the entire fan (housing, wheel, inlet cone and drive frame) or the airstream components (housing, wheel and inlet cone) only.

Spark-Resistant Construction

Greenheck centrifugal fans are available with spark-resistant designs suitable for applications that involve flammable particles, fumes or vapors. Spark resistant construction options adhere to guidelines defined within AMCA Standard 99-0401-86.

Spark A	All parts in contact with the airstream are constructed of nonferrous material (usually aluminum).
Spark B	The fan wheel is constructed of a nonferrous material (usually aluminum). A nonferrous (aluminum) rub ring surrounds the fan shaft where it passes through the fan housing.
Spark C	The inlet cone is constructed of nonferrous material (usually aluminum). A nonferrous (aluminum) rub ring surrounds the fan shaft where it passes through the fan housing.

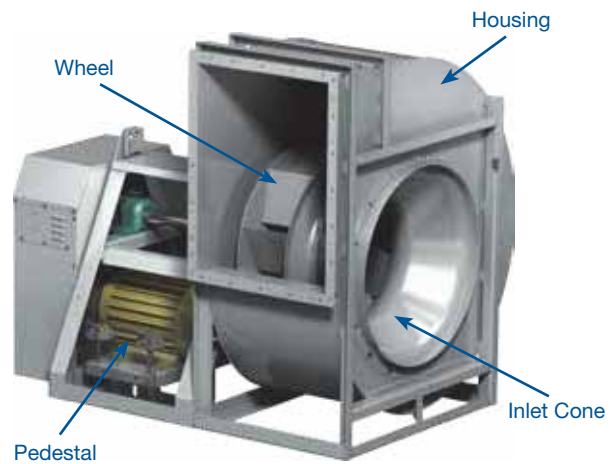

Material Availability by Model and Configuration

Construction	Wheel Type	Construction	Size	Class	Arrangement
Steel	BI/AF	21/41	33 – 73	0, I, II, III, IV,	Any—1, 3, 4, 8, 9, 10
Aluminum, airstream	BI/AF	41	33 – 49	0, I, II, III	1, 9, 10
316 Stainless, entire	BI	41	33 – 49	0, I, II, III	1, 9, 10
316 Stainless, airstream	BI	41	33 – 49	0, I, II, III	1, 9, 10
Spark A	BI/AF	41	33 – 49	0, I, II, III	1, 8, 9, 10
Spark B	BI/AF	21/41	33 – 73	0, I, II, III	1, 8, 9, 10
Spark C	BI/AF	21/41	33 – 73	0, I, II, III	1, 8, 9, 10

*Consult factory for sizes and options beyond what is cataloged.

Split Housings

Quad split housings can solve many space limitation problems in both retrofit and new construction situations.

Not available on 45° discharges TAU, TAD, BAU.

Size limitations:	
Size 7-73	Bolt-on Pedestal Standard
Size 33-73	Quad Split Optional



CSW shown with bolt on pedestal and quad split housing (option)

Emergency Smoke Options (UL Listed)

Greenheck model CSW is available with the UL Power Ventilators for Smoke Control Systems Listing which indicates it is designed and tested to exhaust heat and smoke in an emergency situation. The emergency high temperature option is suitable for the following temperatures:

Operating Temperature	Time Duration
500°F (260°C)	4 hours
572°F (300°C)	2 hours
750°F (400°C)	2 hours
1000°F (538°C)	15 minutes

Model CSW offers:

UL/cUL File #E40001
UL/cUL 705 Listed Power Ventilator

UL/cUL 762 Power Ventilators for Restaurant Exhaust
UL/cUL Power Ventilator for Smoke Control Systems

High temperature options include a heat slinger and shaft seal.

High Temperature Process Construction

The CSW model is available in a wide variety of configurations to meet continuous high temperature exhaust requirements. Our high temperature process packages include a heat slinger, high temperature fan bearing grease, and high temperature paint for steel housed fans.

Temperature Option	Wheel Type	Arrangement	Material
251–500°F (121–260°C)	BI, AF	1, 8, 9, 10	Steel, 316 Stainless Steel*
501–750°F (261–400°C)	BI	1, 8	316 Stainless Steel
751–1000°F (401–538°C)	BI	1	316 Stainless Steel

Note: Aluminum construction is suitable up to 250° F (121°C)
* AF wheels are steel construction only.

UL Listed for Restaurant Grease Exhaust

The CSW-BI centrifugal fan is designed for high pressure restaurant grease exhaust applications. Both the welded and Permalock™ versions of the CSW-BI are available with the UL Listing of Power Ventilators for Restaurant Exhaust Appliances. The welded housing is suitable for indoor or outdoor mounting locations whereas the Permalock housing is suitable for only outdoor kitchen ventilation installations. UL 762 selections require a drain connection and access door.

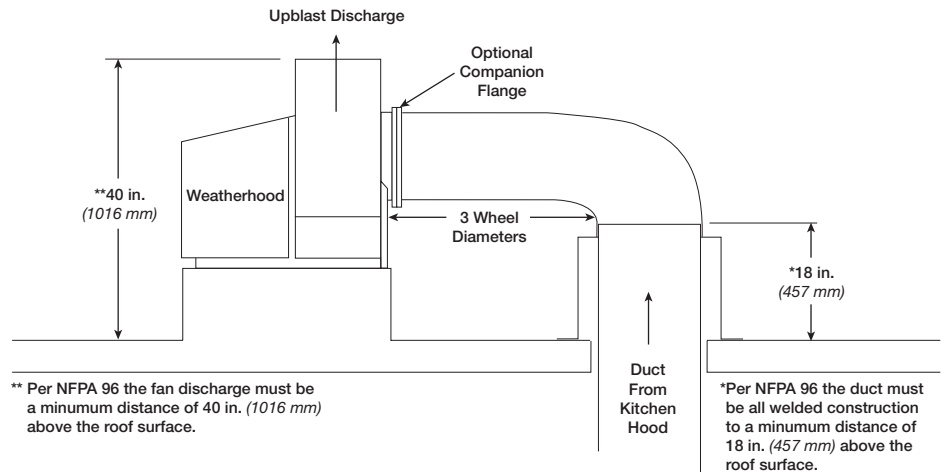

Commercial Kitchen Installation Guide

Due to high temperatures and grease-laden airstreams in commercial kitchen ventilation, system designers must be aware of governing codes and guidelines. The National Fire Protection Association (NFPA) is the primary source for many local codes for commercial kitchen ventilation systems. Local code authorities should be consulted before proceeding with any kitchen ventilation project.

- Installation must include a means for inspecting, cleaning and servicing the exhaust fan.
- Fans selected for grease removal must include a weatherhood, bolted access door, and 1 in. (25 mm) drain connection. For grease applications where the fan is mounted indoors, the welded scroll option (Series 41) must be selected.
- An outlet guard is strongly recommended when the fan discharge is accessible.
- An upblast discharge is recommended.
- The fan must discharge a minimum of 40 in. (1016 mm) above the roof line and the exhaust duct must be fully welded to a minimum distance of 18 in. (457 mm) above the roof surface.
- No dampers are to be used in the system.

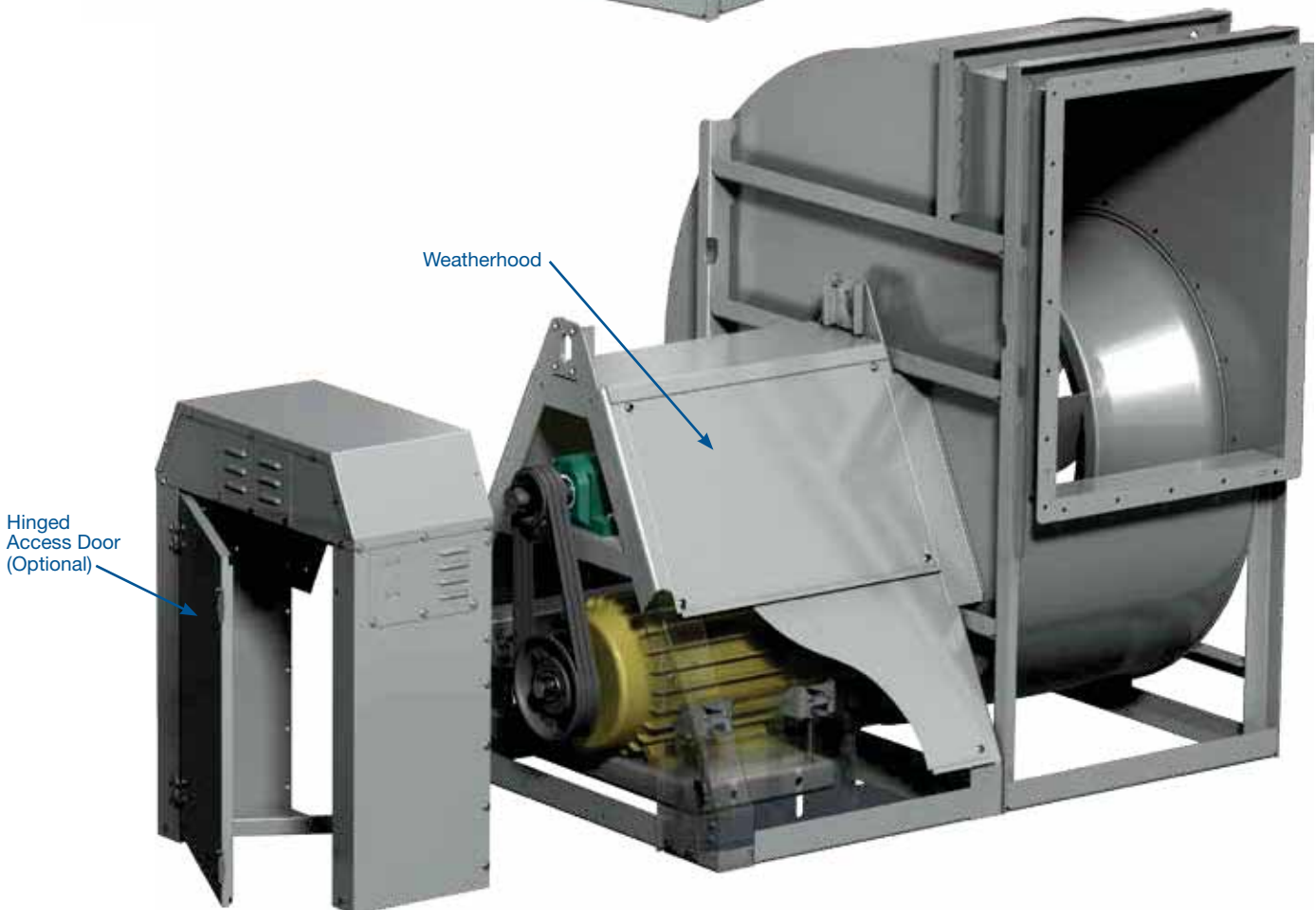
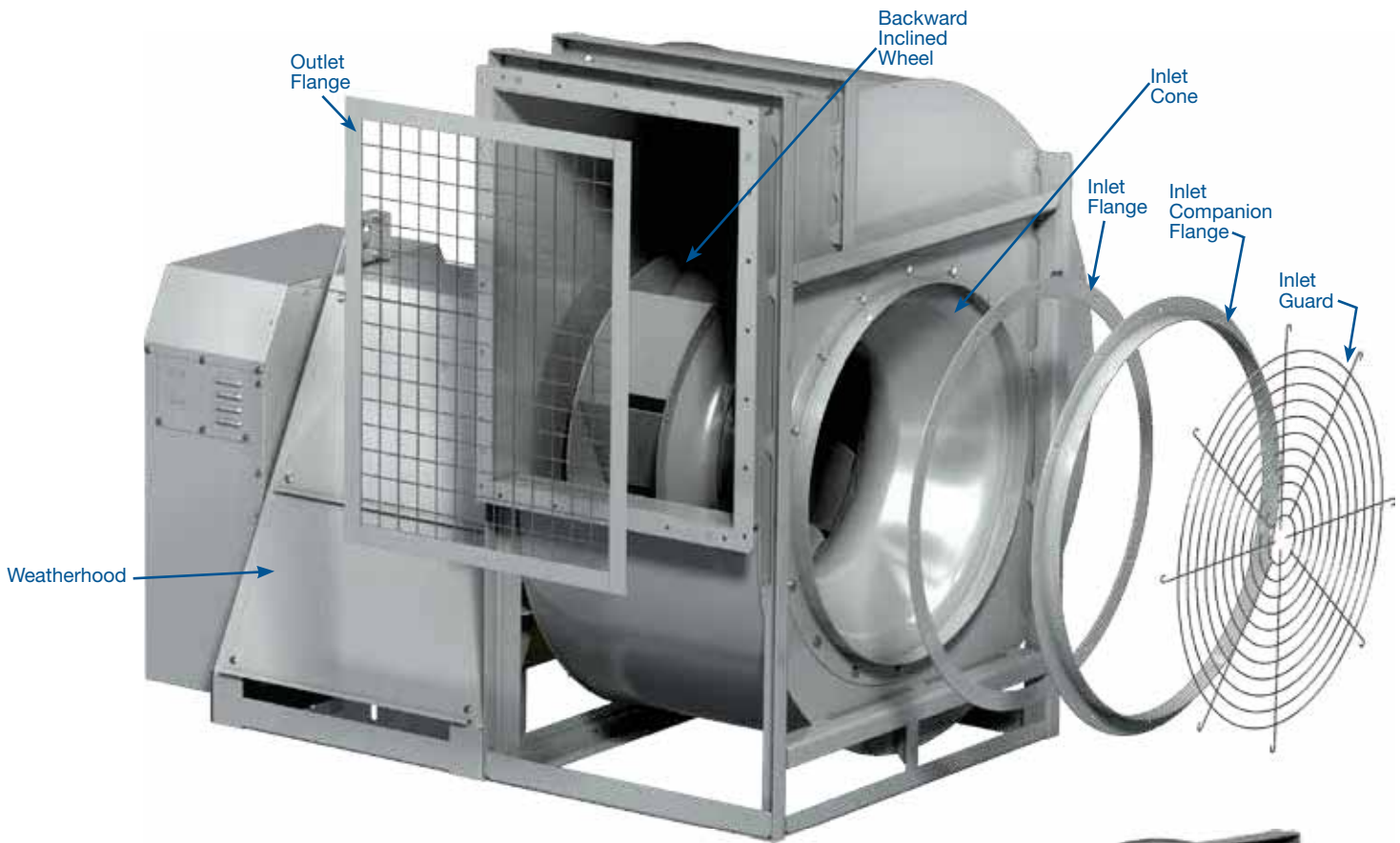

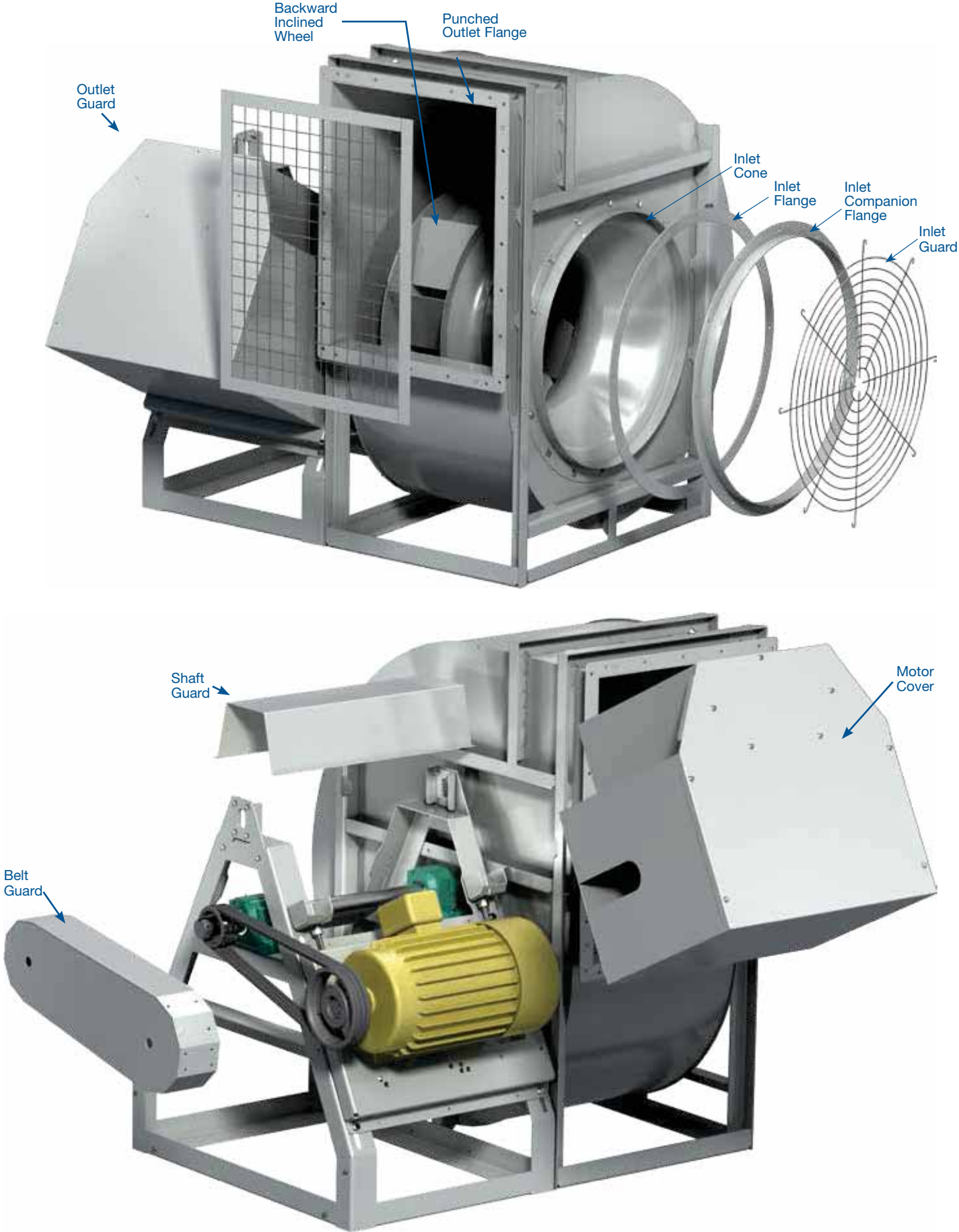

Weatherhoods for Arrangement 10*

Vented steel weatherhoods protect the motor and drive components from rain, moisture, dust, and dirt. Weatherhoods meet OSHA guidelines and are easily removed for service access.

Belt Guard*

Belt guards are designed to allow easy access to the belts and pulleys for service. All belt guards include tachometer openings to monitor the fan speed as well as an access panel for testing belt tension. Belt guards meet OSHA guidelines.

Shaft Guard*

Shaft guards are designed to cover shafts and bearings on arrangements 1, 8, or 9 configurations. Extended lube lines are optional for bearing lubrication without removal of the guard. Shaft guards meet OSHA guidelines.

Motor Cover (Arrangement 9)

A weatherproof motor cover shields the motor components from dust, dirt and moisture for outdoor installations.

Inlet and Outlet Guards*

Removable inlet and outlet guards provide protection for personnel and equipment in non-ducted installations. Inlet and outlet guards meet OSHA guidelines. Steel only.

Inlet and Outlet Flanges*

Optional inlet flanges on all single-width fans are pre-punched and welded to the inlet collar. Punched outlet flanges are standard on fan sizes 33-73.

Inlet Box*

An inlet box is used to minimize entry losses when a 90° turn is required at the fan inlet. Inlet boxes are available with dampers, access doors and drains.

Access Doors*

Bolted or hinged access doors provide access for cleaning or inspection. Access doors are standard on downblast discharge fans.

Inlet Companion Flanges*

Punched companion inlet flanges are available for all single-width fan sizes.

Drain Connection*

A one-inch (25 mm) threaded drain connection is located at the bottom of the fan housing to drain water that may accumulate.

Heat Slings

The heat slinger is an aluminum cooling disc mounted on the fan shaft between the inboard bearing and the blower housing to dissipate heat conducted along the fan shaft. Heat slingers are not available for Arrangement 3 or 4 fans.

Stainless Steel Shafts

Stainless steel fan shafts are available for applications where standard carbon steel shafts may exhibit excessive corrosion or heat stress.

Shaft Seals

A felt, neoprene, or ceramic shaft seal with a rub ring is available for operation at high temperatures or for exhausting contaminated air. Stuffing boxes are available upon request.

Extended Life Bearings

Extended life bearings are selected for a basic rating fatigue life L_{10} per ABMA Standards in excess of 200,000 hours at the maximum RPM. L_{10} is the life associated with 90% reliability of a bearing.

Extended Lubrication Lines

Single-width fans are available with flexible nylon or copper tubing extending from the bearings to conveniently located grease fittings mounted on the fan pedestal (or on the exterior of weatherhood if a weatherhood is supplied).

Disconnect Switches

Greenheck offers a wide selection of NEMA rated fusible or non-fusible disconnect switches. Switches can be factory mounted or shipped loose for field installation.

Grease Containment

Grease trap designed to collect grease residue to avoid drainage onto roof surface. Grease traps ship loose for field installation.

Backdraft Dampers

Backdraft dampers are available in galvanized, painted steel or aluminum construction and include counterweights for tight closure when the fan is de-energized.

**These accessories are available in Aluminum or Stainless Steel construction.*

Protective Coatings

Greenheck offers a wide variety of protective coatings suitable for corrosive applications. All coatings are electrostatically-applied baked powders that offer a durable, long lasting finish. For more information on our complete offering of coatings, visit www.greenheck.com and navigate to Library/Application Articles. Search for [Performance Coatings for Ventilation Products](#).

Zinc Advantage

For corrosive environments (outdoor, coastal, laboratory), discover Greenheck's zinc-rich basecoat technology. Our advanced two-coat powder application includes a basecoat of zinc-rich epoxy powder and a topcoat of Greenheck's Permator™ or Hi-Pro Polyester.

The sacrificial protection offered by the zinc-rich basecoats in Perma-Z and Hi-Pro Z result in extraordinary corrosion resistance. Test data demonstrates our two-coat paint system offers three (Perma-Z) and four (Hi-Pro Z) times the corrosion resistance of other coatings commonly available within the fan industry.

For more information about the zinc advantage, see Greenheck's [Coatings for Extreme Applications](#) catalog, available on-line at www.greenheck.com.

Two Coat Process

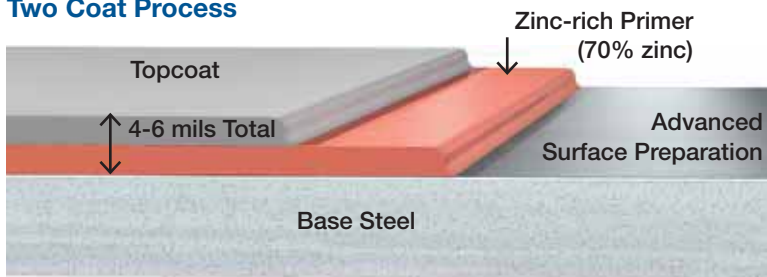

Salt Spray ASTM B117				
Hours	1000	2000	3000	4000
Permator™	██████████			
Hi-Pro Poly	██████████			
Perma-Z	██████████	██████████	██████████	
Hi-Pro-Z	██████████	██████████	██████████	██████████
Baked Phenolic	██████████			
Epoxy Phenolic	██████████			
Fluorocarbon	██████████			

Salt Spray ASTM B117 is a comparative test that indicates the corrosion resistance of powder paint coatings.

Vibration Isolators and Isolation Bases

Greenheck offers a complete package of steel isolation bases, inertia bases and vibration isolators to simplify field assembly and reduce transmitted vibrations. Arrangement 1 and 3 isolation bases include a motor adjustment (vertical adjustment on X/Y) base for belt adjustments. Additionally, bases are available with height savings brackets to keep the base and fan center of gravity lower to the mounting surface.

Steel bases consist of laser formed steel members welded into a rigid one piece base. Bases are available without isolators or with rubber or spring mount isolators.

Inertia bases may be desirable when steel bases do not provide sufficient mass or where discharge velocities cause greater reaction forces. Concrete is provided by others.

Refer to Mounting Bases and Vibration Isolation on the catalog pages on www.greenheck.com.

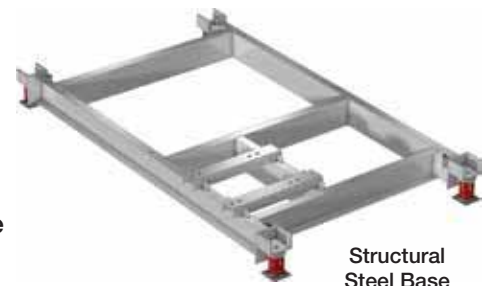

Structural Steel Base



Inertia Base



Neoprene



Free Standing



Housed



Restrained

Inlet Boxes

Inlet boxes are used to accomplish a 90 degree turn at the fan inlet. A factory designed inlet box will provide predictable minimal entry losses normally associated with a 90 degree turn at the fan inlet.

Orientation is determined from the drive side of the fan. Positions start at 360° (see figure) and rotate clockwise in 45° increments.

135°, 180°, and 225° positions have special design considerations in regard to structural clearances, bases and dampers. Consult factory with your application requirements.

Inlet box dampers are also available.

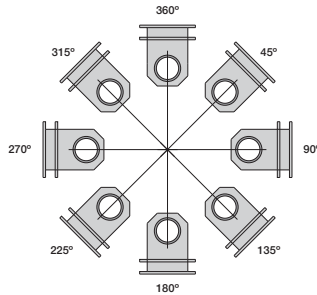

Volume Control

VFD Rated Motors

Variable Frequency Drives (VFD's) change the frequency of the input power to the motor, which results in changing the motor's speed. Changing the speed of the fan provides the greatest potential for energy savings at partial loads.

External Inlet Vanes

External inlet vane dampers are mounted externally on the fan inlet flange and are available for fan sizes 33-60. External inlet vanes extend beyond the fan inlet. Electric or pneumatic actuators are available. The maximum operating temperature for inlet vanes is 200° F (93° C).



Volume Control Dampers

Control dampers are available in painted steel, aluminum or stainless steel. Options include manual quadrants (manual operation), electric actuators, or pneumatic actuators.



Sure-Aire™

The Sure-Aire airflow monitoring station measures fan flow within an accuracy of 3%. Unlike traditional flow probes mounted in the fan venturi that create a system effect hindering a fan's performance, Sure-Aire does not interfere with airflow and will not impact the fan's air or sound performance. This option is available on all centrifugal series products and ships completely assembled from our factory.

An electronics package with pressure transmitter and digital read out is available with the Sure-Aire system. The electronic kits are available for 50 or 60 Hz power supplies and provide a 4-20 mA or 0-10 volt output that can be tied into the building's automation system.



Motor Starters

The fundamental function of a motor starter is to protect the motor from damage that can occur from overheating. With a Greenheck motor starter you will be provided with the best motor protection available.



Specific model components may include; SmartStart™ technology, physical interface, overload protection, disconnect, magnetic contactor, NEMA-1 or NEMA-3R steel enclosures and pre-engineered easy system integration. For complete information on specific Greenheck Motor Starter models refer to greenheck.com, Motor Starter web page.

Selection data for the model CSW can be found in our CSW Performance Supplement and online at www.greenheck.com.

Selection

The first consideration in any fan selection is the amount of air to be moved and the resistance to this air movement. Air volume requirements are established through specific codes or accepted industry standards. Once the air volume is known, system resistance can be determined by summing up the losses through the system components. Duct layout, duct size, coil, filters, dampers and fan accessories all affect system resistance. "ASHRAE Guide and Data Books" and manufacturer's data on individual system components are common sources of information available to the system designer.

In most applications, several fans may meet the required airflow and system resistance conditions. An optimum fan selection requires evaluation of alternative fan types and fan sizes, as they relate to initial cost, operating cost, available space and allowable sound levels. The relative importance of these facts varies with each system.

When deciding on a specific fan size, consider selections that allow for adjustments after installation. Avoid selecting fans that are within 10% of the maximum fan RPM or max motor horsepower capacity. If a selection is within 10% of capacity, upgrade to the next class of construction if possible. Avoid selections near the fan "stall" if there is potential variability in pressure. Operation in stall conditions will result in low fan performance and potential vibration issues. Watch for fan selections with excessive fan RPM's (above 2700 fan RPM) as these can generate higher sound levels. Select a slower running fan (typically a larger diameter wheel) if possible. Please contact your local Greenheck Representative if you need any assistance in reviewing fan selections.

Effects of Installation on Performance

Fan ratings presented in the performance tables and curves are in accordance with AMCA Standard 210 "Laboratory Methods of Testing Fans for Aerodynamic Performance Rating". The AMCA test procedure utilizes an open inlet and a straight outlet duct to assure maximum static regain.

Any installation with inlet or discharge configurations that deviate from this standard may result in reduced fan performance. Restricted or unstable flow at the fan inlet can cause pre-rotation of incoming air or uneven loading of the fan wheel yielding large system losses and increased sound levels. Free discharge or turbulent flow in the discharge ductwork will also result in system effect losses.

The examples below show system layouts and inlet and discharge configurations which can affect fan performance.

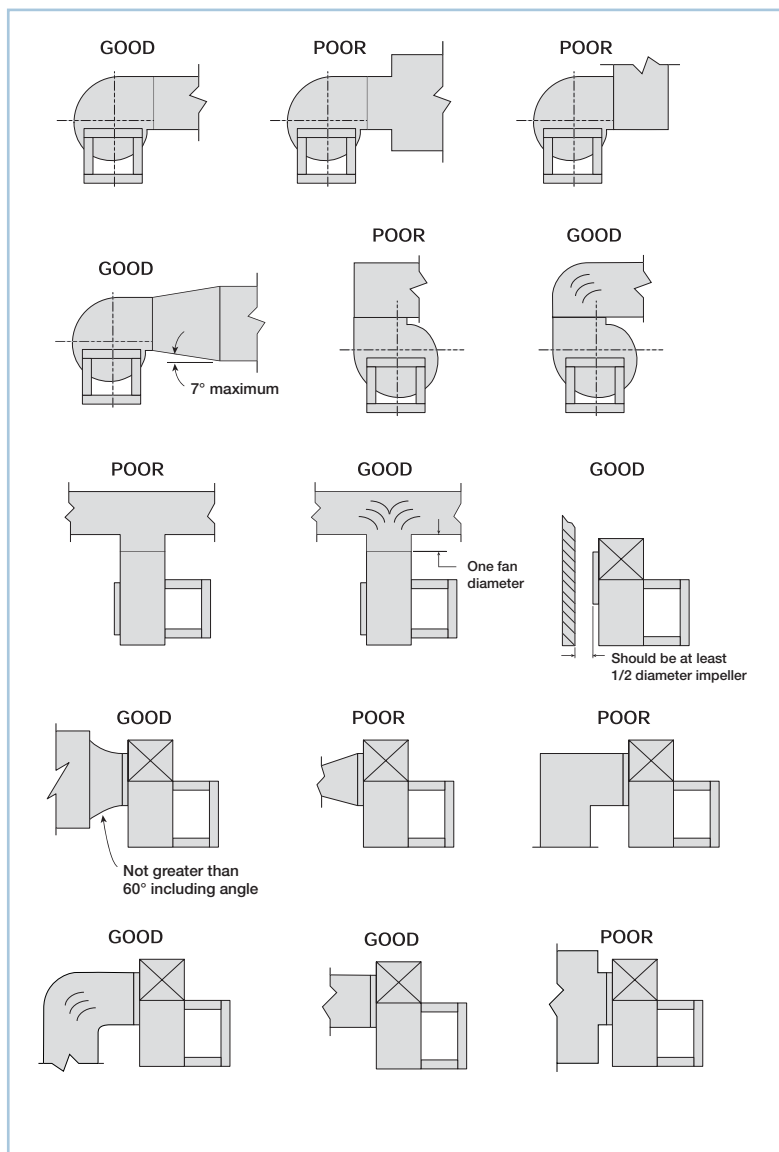

Design and Selection Support

Computer Aided Product Selection — CAPS

All Greenheck products are supported by the industry's best product literature, electronic media, and Computer Aided Product Selection program, CAPS. Online, you can also find electronic copies of our product literature as well as storage, installation and maintenance information in our Installation and Operation Manuals.

And, of course, you can always count on the personal service and expertise of our national and international representative organization. To locate your nearest Greenheck representative call 715-359-6171 or visit our website at www.greenheck.com



To-Scale Drawings and Fan Specifications

To-scale CAD drawings and Revit models along with detailed centrifugal specifications can be found online at www.greenheck.com or within our Computer Aided Product Selection program (CAPS).

Building Value in Air

Greenheck delivers value to mechanical engineers by helping them solve virtually any air quality challenges their clients face with a comprehensive selection of

top quality, innovative air-related equipment. We offer extra value to contractors by providing easy-to-install, competitively priced, reliable products that arrive on time.

And building owners and occupants value the energy efficiency, low maintenance and quiet dependable operation they experience long after the construction project ends.

Our Commitment

As a result of our commitment to continuous improvement, Greenheck reserves the right to change specifications without notice.

Specific Greenheck product warranties are located on greenheck.com within the product area tabs and in the Library under Warranties.



Prepared to Support
Green Building Efforts

