

## Active and Passive Beams

- Factory Design Tools and Assistance



## Displacement Ventilation

- Customization and Architectural Integration



## Fan Coils

- Efficient, Quiet, and Customizable units with ECM Motors
- 10-12”H Low profile handles .5 to .7” of ESP
- Up to 8 Rows of Total Coil
- Hospital Grade Construction and Liners
- Tuned Attenuation Available

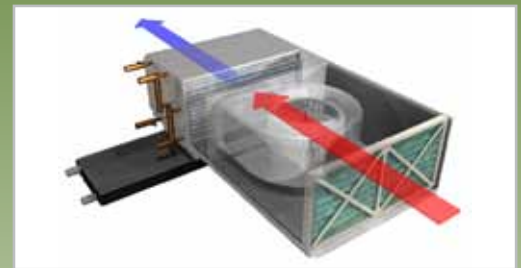

## Noise Control

- Industrial and Custom Applications



## Building a Better Environment



Grilles & Diffusers

Terminals & Controls

Critical Environments

Sustainable Building

Noise Control

Energy Efficient Solutions  
Made Easy

On-Time Delivery

Industry Leading Applications  
Support

Fully Customizable

Worldwide Supplier of Preference for Air Distribution  
Visit [www.price-hvac.com](http://www.price-hvac.com) to find out more

**PRICE**<sup>®</sup>

# 4 PRICE® Aluminum Ceiling Diffusers

## Model AMD - Aluminum, Louvered Face Directional Diffuser

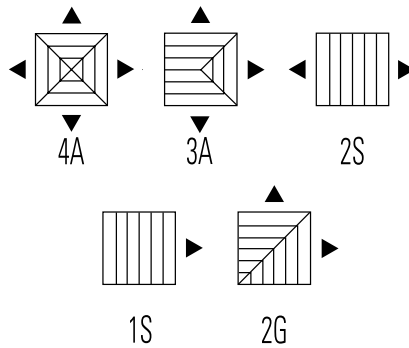

- Models Available:**
- ◆ AMD1..... Flat Frame, Surface Mount
  - ◆ AMD3PA..... T-Bar
  - AMDEX3PA..... High Induction, T-Bar

Size	Patterns Stocked					CFM @ 500FPM Neck Velocity	List Prices				
	4A	3A	2S	1S	2G		Model AMD1	Model AMD3PA	Model AMDEX3PA	Damper Model VCS3	Transition Model TR3
6 x 6	◆ ■	◆				125	\$74.	\$140.	\$159.	\$17.	\$18.
9 x 9	◆ ■	◆			◆	281	94.	157.	171.	23.	21.
12 x 12	◆ ■	◆				500	125.	188.	233.	28.	25.
15 x 15	◆ ■	◆				781	159.	224.	296.	38.	34.
18 x 18	◆					1125	205.	205.	--	42.	48.

All dimensions are in inches.  
Finish is B12 White.

① Stocked in Hanover and Newington only.

## Model LCMD1 - Aluminum, Light Commercial Directional Diffuser with Beveled Frame and Damper

Size	Patterns Stocked			CFM @ 500FPM Neck Velocity	List Prices		
	4A	3A	2G		Pattern		Transition Model TR3
					4A, 3A	2G	
6 x 6	•	•	•	125	\$51.	\$70.	\$18.
8 x 8	•	•	•	230	58.	78.	21.
10 x 10	•	•	•	350	76.	92.	25.
12 x 12	•	•	•	500	84.	102.	25.
14 x 14	•			690	98.	--	34.

All dimensions are in inches.  
Finish is B12 White. Price includes damper. Face-screw mounting.



## Model SMD - Steel, Louvered Face Directional Diffuser

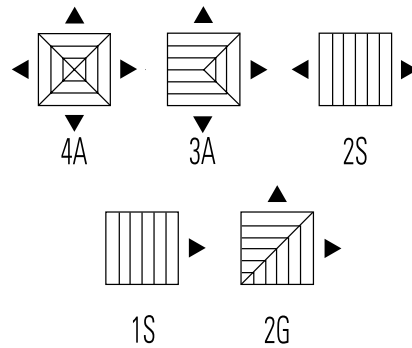
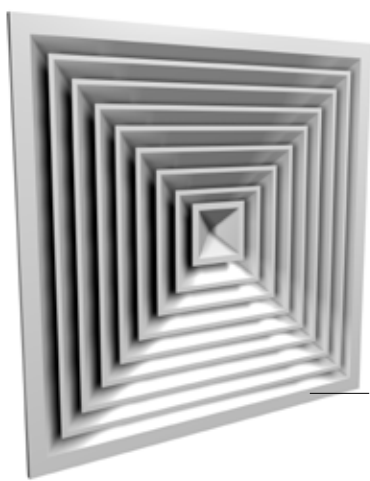

### Models Available:

- ◆ SMD1..... Flat Frame, Surface Mount
- ◆ SMD3P..... T-Bar
- SMD6..... Beveled Frame, Surface Mount
- SMD17P..... Finline

Size	Patterns Stocked					CFM @ 500FPM Neck Velocity	List Prices					
	4A	3A	2S	1S	2G		Model SMD1	Model SMD3P	Model SMD6	Model SMD17P	Damper Model VCS3	Transition Model TR3
6 x 6	◆●■	◆■	◆	◆	◆	125	\$51.	\$81.	\$62.	\$114.	\$17.	\$18.
9 x 9	◆●■	◆■	◆	◆	◆	282	65.	95.	73.	125.	23.	21.
12 x 12	◆●■	◆■	◆	◆	◆	500	83.	117.	98.	149.	28.	25.
15 x 15	◆●■	◆				781	109.	143.	121.	174.	38.	34.
18 x 18	◆	◆				1125	142.	142.	--	--	42.	48.
21 x 21	◆					1531	--	220.	--	--	62.	57.

All dimensions are in inches.

Finish is B12 White.

Ⓜ SMD17P stocked in Hanover only.

## Model SMX3P - Steel, High Induction Directional Diffuser with T-Bar Mount

Size	Patterns Stocked					CFM @ 500FPM Neck Velocity	List Prices		
	4A	3A	2S	1S	2G		Model SMX3P	Damper Model VCS3	Transition Model TR3
6 x 6	•					125	\$121.	\$17.	\$18.
9 x 9	•					282	135.	23.	21.
12 x 12	•					500	150.	28.	25.
15 x 15	•					781	185.	38.	34.

All dimensions are in inches.

Finish is B12 White.

Ⓜ Stocked in Hanover and Newington only.

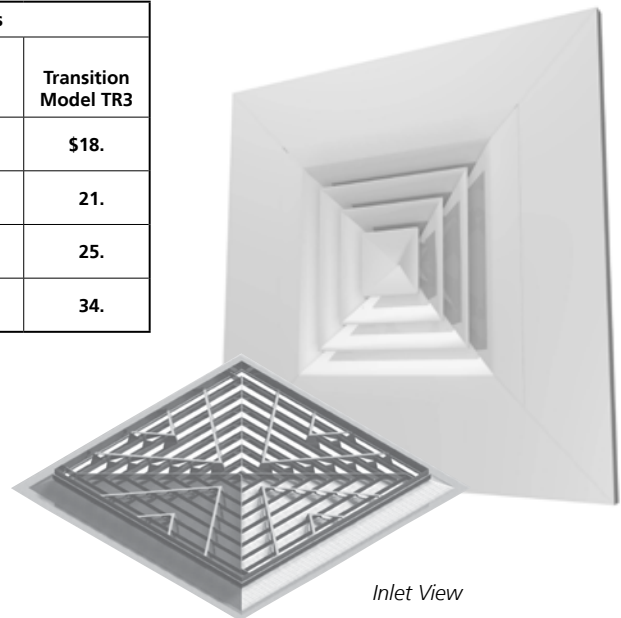

Inlet View

# PRICE® Steel Ceiling Diffusers

AIR DISTRIBUTION PRODUCTS

## Model SCD31 - Steel, Square 3-Cone Diffuser with Round Neck for T-Bar Mount

Size	CFM @ 500FPM Neck Velocity	List Prices			
		Model SCD31		Blow Pattern Air Baffle (ea) Model AB1	Damper Model VCR9
		12x12 T-Bar	24x24 T-Bar		
6	157	\$69.	\$82.	\$20.	\$21.
8	279	69.	82.	20.	23.
10	436	--	82.	20.	26.
12	628	--	82.	20.	28.
14	855	--	82.	20.	40.
15	982	--	82.	20.	46.*



All dimensions are in inches.  
Finish is B12 White.

\* Damper Model is VCR8

## Model SPD - Steel, Square Plaque Diffuser with Round Neck

Size	CFM @ 500FPM Neck Velocity	List Prices					
		Model SPD31		Model SPD31HI	Model SPD17	Blow Pattern Air Baffle (ea) Model AB2	Damper Model VCR9
		12x12 T-Bar	24x24 T-Bar				
6	157	\$67.	\$82.	\$222.	\$121.	\$13.	\$21.
8	279	67.	82.	222.	121.	13.	23.
10	436	--	82.	222.	121.	13.	26.
12	628	--	82.	222.	121.	13.	28.
14	855	--	82.	--	121.	13.	40.
15	982	--	82.	--	--	13.	46.*



All dimensions are in inches.  
Finish is B12 White.

\* Damper Model is VCR8

Ⓢ Model SPD31-HI stocked in Hanover only.

### Models Available:

- SPD31..... T-Bar
- SPD17..... Fineline
- SPD31HI ..... High Induction, T-Bar

## Model RCDE - Steel, Round Diffuser

Size	CFM @ 500FPM Neck Velocity	List Prices	
		Model RCDE	Damper Model VCR7
6	160	\$129.	\$47.
8	280	135.	49.
10	435	147.	51.
12	630	161.	65.
14	850	186.	74.



All dimensions are in inches.  
Finish is B12 White.

## Touch Up Paint

For use with Price products with a B12 white finish or B15 aluminum finish.

- PAINTB12.....White Finish
- PAINTB15.....Aluminum Finish

List Price \$25.



# PRICE® Steel Ceiling Diffusers

## Model PDF3, PDC3 - Steel, Perforated Supply Diffuser with Round Neck

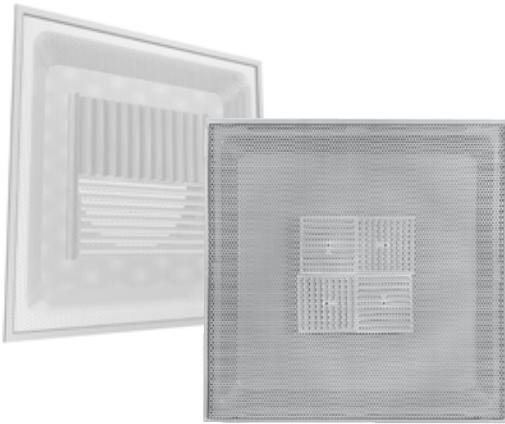

Size	CFM @ 500FPM Neck Velocity	List Prices		
		Model PDF3	Model PDC3	Damper Model VCR9
6	98	\$69.	\$80.	\$21.
8	175	69.	80.	23.
10	273	69.	86.	26.
12	393	69.	86.	28.
14	535	69.	94.	40.
16	698	93.	--	--

**Models Available:**

- PDC3..... Curved Grate, T-Bar
- PDF3..... Cheese Blade, T-Bar

*All dimensions are in inches.  
Finish is B12 White. Model PDC3 stocked in 4-Way air pattern only.*

## Model PDDR - Steel, Perforated Return Diffuser with Round or Square Duct Connection for T-Bar Ceilings



Size	CFM @ 500FPM Neck Velocity	List Price
		Square
6 x 6	125	\$68.
8 x 8	222	68.
10 x 10	347	68.
12 x 12	500	68.
14 x 14	681	68.
18 x 18	1125	79.
22 x 10	764	66.
22 x 22	1681	58.

Size	CFM @ 500FPM Neck Velocity	List Price
		Round
6	98	\$63.
8	175	63.
10	273	63.
12	393	63.
14	535	63.
16	698	82.

*All dimensions are in inches. Finish is B12 White.*

## Model PFRF3 - Steel, Perforated Face Return Diffuser    Model APF - Aluminum Plaster Frame



**Models Available:**

- PFRF3.....T-Bar, No Frame
  - APF.....Plaster Frame
- To make t-bar diffuser fit plaster or gypsum board ceiling.

Size	CFM @ 500FPM Neck Velocity	List Prices	
		Model PFRF3	Model APF
12 x 12		--	\$55.
24 x 12	878	\$28.	65.
24 x 24	1837	40.	66.
48 x 24		--	117.

*All dimensions are in inches.  
Finish is B12 White.*

# 8 PRICE® Slot Diffusers, Spiral Register

## Model TBDI4100 - Insulated Slot Diffuser with T-Bar Mount

Model	# of Slots	Dimensional Data				CFM Range	List Prices	
		Length	Height	Width	Inlet (Oval)		Slot Diffuser	Plaster Frame Model APF
TBDI4100 (1" Slot)	2	24	10	4	6, 8	59 - 274	\$123.	\$37.
		48	12	4	8, 10	105 - 489	165.	49.
TBDI4150 (1½" Slot)	2	48	12	5	12	138 - 644	165.	--
	3	48	12	7½	12	164 - 764	239.	--

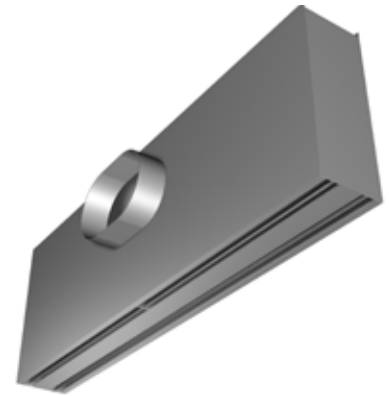

All dimensions are in inches.

Note: Plaster Frame Model APF is to be used for installation of slot diffuser Model TBDI in sheet rock or plaster ceilings.

## Model SDS100 - Linear Slot Diffuser with 1" Slot Spacing

Length	# of Slots	CFM Range	List Prices		
			Model SDS100-2	Model SDS100-14	Plenum Model BDP (Insulated)
24	2	32 - 256	\$108.	\$108.	\$85.
48	2	64 - 512	203.	203.	143.
48	3	96 - 768	275.	--	169.

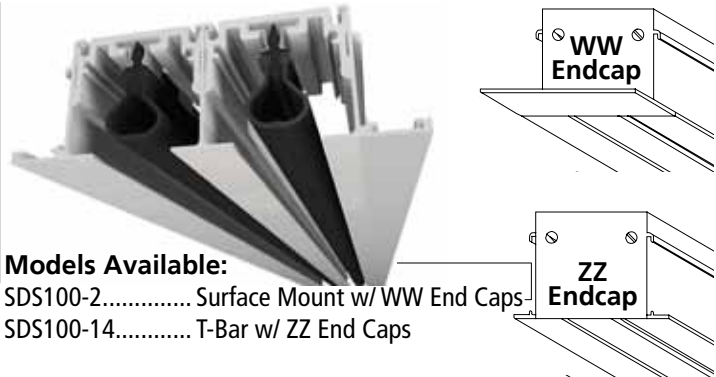

All dimensions are in inches.

Finish is B12 White on Frame, Black Pattern Controllers

### Models Available:

SDS100-2..... Surface Mount w/ WW End Caps

SDS100-14..... T-Bar w/ ZZ End Caps

## Model SDG - Steel, Spiral Duct Register

Size	CFM @ 300FPM Neck Velocity	Duct Diameter	List Price
12 x 4	78	8-13	\$129.
18 x 4	117		151.
12 x 6	117	14-21	137.
16 x 6	156		156.
20 x 6	207		172.
24 x 6	254		202.
16 x 8	243	22-31	164.
18 x 8	270		172.
24 x 8	354		212.



All dimensions are in inches.

Finish is B15 Aluminum, includes air scoop.

## Spiral Pipe & Fittings

pages  
34-35

## Model 520SD - Steel, Double Deflection Supply Register with Damper

Size	CFM @ 500FPM Neck Velocity	List Price
6 x 4	59	\$55.
8 x 4	81	55.
10 x 4	104	63.
12 x 4	126	66.
14 x 4	149	66.
16 x 4	171	74.
18 x 4	194	76.
20 x 4	216	80.
24 x 4	261	92.
6 x 6	95	63.
8 x 6	132	63.
10 x 6	168	63.
12 x 6	205	68.
14 x 6	241	76.
16 x 6	277	80.
18 x 6	314	89.
20 x 6	350	92.
24 x 6	423	101.
8 x 8	182	66.
10 x 8	232	71.
12 x 8	283	80.
14 x 8	333	83.
16 x 8	383	91.
18 x 8	433	95.
20 x 8	484	105.

Size	CFM @ 500FPM Neck Velocity	List Price
24 x 8	584	\$121.
30 x 8	735	161.
36 x 8	886	178.
10 x 10	296	76.
12 x 10	361	87.
14 x 10	425	95.
16 x 10	489	101.
18 x 10	553	109.
20 x 10	617	116.
24 x 10	746	136.
30 x 10	938	177.
36 x 10	1131	202.
12 x 12	439	92.
14 x 12	517	98.
16 x 12	595	112.
18 x 12	673	121.
20 x 12	751	127.
22 x 12	800	142.
24 x 12	907	151.
30 x 12	1141	200.
36 x 12	1375	230.
14 x 14	609	112.
16 x 14	701	124.
18 x 14	793	129.
20 x 14	885	144.



Size	CFM @ 500FPM Neck Velocity	List Price
24 x 14	1068	\$165.
30 x 14	1344	225.
16 x 16	806	142.
24 x 16	1230	180.
30 x 16	1547	250.
36 x 16	1865	283.
18 x 18	1032	165.
24 x 18	1391	200.
30 x 18	1750	271.
36 x 18	2110	316.
20 x 20	1285	195.
24 x 24	1875	272.

All dimensions are in inches.  
Finish is B12 White.

## Model 540 - Steel, Single Deflection Supply Register with Damper

Size	CFM @ 500FPM Neck Velocity	List Price
10 x 4	104	\$37.
12 x 4	126	39.
14 x 4	149	44.
6 x 6	95	37.
10 x 6	168	41.
12 x 6	205	44.
14 x 6	241	47.

Size	CFM @ 500FPM Neck Velocity	List Price
8 x 8	182	\$39.
10 x 8	232	44.
12 x 8	283	47.
14 x 8	333	49.
16 x 8	383	54.
20 x 8	484	57.
12 x 12	439	54.

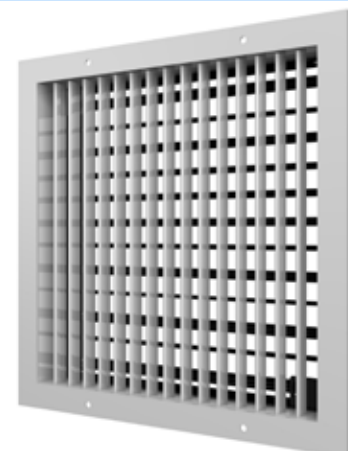

All dimensions are in inches. Finish is B12 White.

# PRICE® Return Grilles & Registers

## Model 530 - Steel, 45 Degree Single Deflection Return Grille

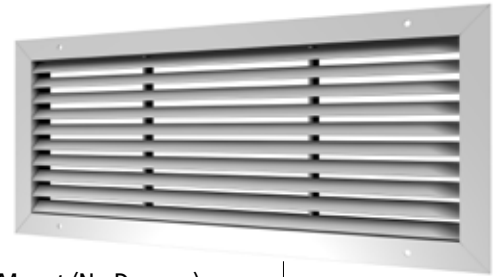

Size	CFM @ 500FPM Neck Velocity	List Prices			
		Model 530L	Model 530LD	Model 530L3P	Model 530L17
6 x 4	59	\$33.	--	--	--
8 x 4	82	33.	--	--	--
10 x 4	104	33.	\$52.	--	--
12 x 4	127	33.	--	--	--
22 x 4*	240	48.	--	--	--
6 x 6	96	33.	52.	\$89.	--
8 x 6	132	33.	52.	--	--
10 x 6	169	33.	52.	--	--
12 x 6	205	38.	59.	--	--
14 x 6	242	38.	--	--	--
22 x 6*	387	54.	--	--	--
24 x 6	424	54.	--	--	--
30 x 6	533	69.	--	--	--
8 x 8	183	33.	52.	89.	--
10 x 8	233	38.	59.	--	--
12 x 8	283	38.	63.	--	--
14 x 8	334	46.	--	--	--
16 x 8	383	48.	70.	--	--
18 x 8	434	52.	--	--	--
22 x 8*	535	59.	--	--	--
24 x 8	585	60.	--	--	--
30 x 8	736	71.	--	--	--
10 x 10	297	45.	63.	100.	--
12 x 10	361	45.	66.	--	--
14 x 10	426	48.	71.	--	--
16 x 10	490	52.	--	--	--
18 x 10	554	55.	--	--	--
20 x 10	618	55.	--	--	--
22 x 10*	683	59.	89.	--	\$88.
24 x 10	747	59.	--	--	--
30 x 10	939	74.	--	--	--
36 x 10	1132	83.	--	--	--
12 x 12	439	48.	68.	102.	--
14 x 12	518	52.	--	--	--
16 x 12	596	55.	--	--	--
18 x 12	674	57.	89.	--	--
20 x 12	752	63.	92.	--	--
24 x 12	908	63.	--	--	--
30 x 12	1143	80.	--	--	--
36 x 12	1377	89.	--	--	--
48 x 12	1846	127.	--	--	--
14 x 14	610	55.	83.	109.	--
18 x 14	794	60.	--	--	--
20 x 14	886	63.	--	--	--

### Models Available:

- 530L.....Surface Mount (No Damper)
- 530LD.....Surface Mount with Damper
- 530L3P.....T-Bar (24x 24 Panel), No Damper
- 530L17.....Fineline, No Damper

Size	CFM @ 500FPM Neck Velocity	List Prices			
		Model 530L	Model 530LD	Model 530L3P	Model 530L17
16 x 16	808	\$59.	\$94.	\$116.	--
18 x 16	913	94.	--	--	--
20 x 16	1019	68.	--	--	--
24 x 16	1231	74.	--	--	--
30 x 16	1549	92.	--	--	--
12 x 18	674	63.	--	--	--
18 x 18	1033	68.	112.	124.	--
20 x 18	1225	72.	--	--	--
24 x 18	1393	77.	--	--	--
30 x 18	1752	98.	--	--	--
36 x 18	2111	119.	--	--	--
14 x 20	886	69.	--	--	--
20 x 20	1287	74.	--	--	--
24 x 20	1554	83.	--	--	--
30 x 20	1955	112.	--	--	--
36 x 20	2356	121.	--	--	--
22 x 22*	1568	83.	145.	--	\$122.
46 x 22*	3339	158.	--	--	--
12 x 24	908	68.	--	--	--
14 x 24	1070	78.	--	--	--
18 x 24	1393	86.	--	--	--
20 x 24	1554	92.	--	--	--
24 x 24	1877	92.	172.	--	--
30 x 24	2361	121.	--	--	--
36 x 24	2846	133.	--	--	--
48 x 24	3814	228.	--	--	--
14 x 30	1346	96.	--	--	--
20 x 30	1955	124.	--	--	--
24 x 30	2361	134.	--	--	--
30 x 30	2971	139.	--	--	--
36 x 30	3580	163.	--	--	--
48 x 30	4799	295.	--	--	--
36 x 36	4314	177.	--	--	--
48 x 36	5783	366.	--	--	--
24 x 48	3814	251.	--	--	--

All dimensions are in inches. Finish is B12 White.  
 Sizes listed are Width x Height.

\* Asterisk denotes lay-in t-bar without face screws.

## Model 630 - Aluminum, 45 Degree Single Deflection Return Grille

Size	CFM @ 500FPM Neck Velocity	List Prices	
		Model 630L	Model 630L3P
6 x 6	96	\$45.	--
8 x 8	183	47.	--
10 x 10	297	52.	--
12 x 12	439	57.	--
14 x 14	610	68.	--
22 x 10 (24x12 TBAR)	683	--	\$73.
22 x 22 (24x24 TBAR)	1568	--	115.

All dimensions are in inches. Finish is B12 White.

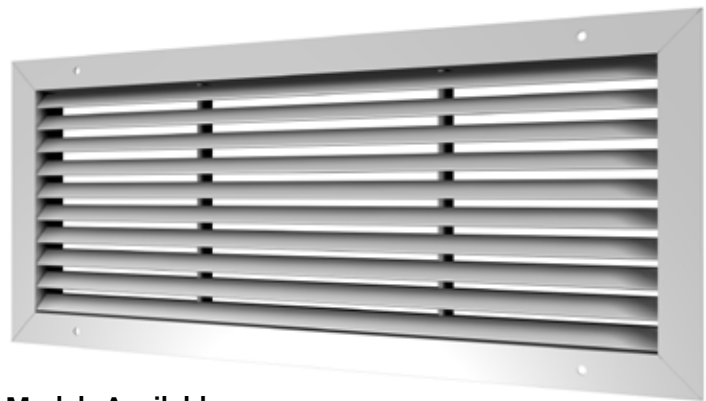

**Models Available:**  
 630L.....Surface Mount (No Damper)  
 630L3P.....T-Bar (No Damper)

## Model 80 - Aluminum Egg Crate Grille/Register

Size	CFM @ 500FPM Neck Velocity	List Prices			
		Model 80	Model 80D	Model 803P	Model 80SGG
6 x 6	91	\$27.	\$53.	\$81.	--
8 x 8	176	33.	55.	88.	--
10 x 10	289	40.	66.	96.	--
22 x 10 (24x12 TBAR)	669	62.	--	--	\$78.
12 x 12	430	46.	75.	101.	--
14 x 14	598	59.	97.	112.	--
16 x 16	794	66.	--	--	--
18 x 18	1018	79.	--	133.	--
20 x 20	1270	92.	--	147.	--
22 x 22 (24x24 TBAR)	1550	92.	152.	--	115.
46 x 22 (48x24 TBAR)	3310	194.	--	--	243.
24 x 24	1857	118.	--	--	--
48 x 24	3784	248.	--	--	--

All dimensions are in inches. Finish is B12 White.

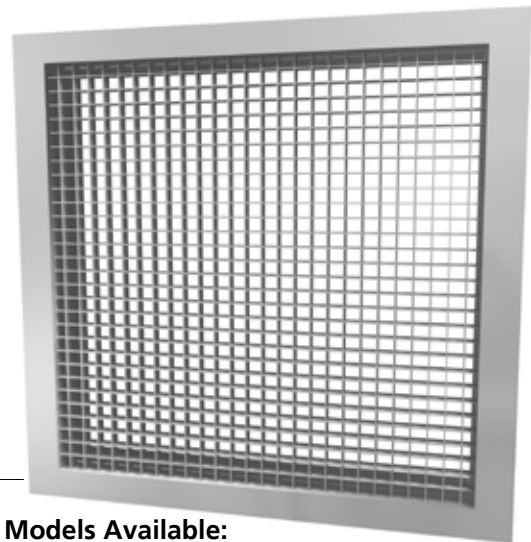

**Models Available:**  
 80.....Surface Mount (No Damper)  
 80D.....Surface Mount with Damper  
 803P.....T-Bar (No Damper)

**Hide Exposed Ductwork with the New Sight-Guard 45° Egg Crate Grille**

80SGG.....Sight-Guard, T-Bar (No Damper)

### Egg Crate

Size	List Prices	
	Plastic	Aluminum
24 x 24	\$21.	\$63.
48 x 24	35.	117.

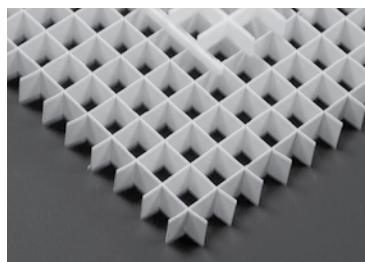

egg crate at a 45° angle limits view into ductwork above

**Model LBPHD25C** - Aluminum, 0° Deflection Linear Floor Register with Damper and Pencil Proof Spacing

Size	CFM Range	List Price
10 x 4	41 - 183	\$110.
12 x 4	49 - 220	116.
14 x 4	57 - 257	121.
10 x 6	65 - 291	123.
12 x 6	78 - 349	143.
14 x 6	91 - 407	157.
18 x 6	117 - 524	173.

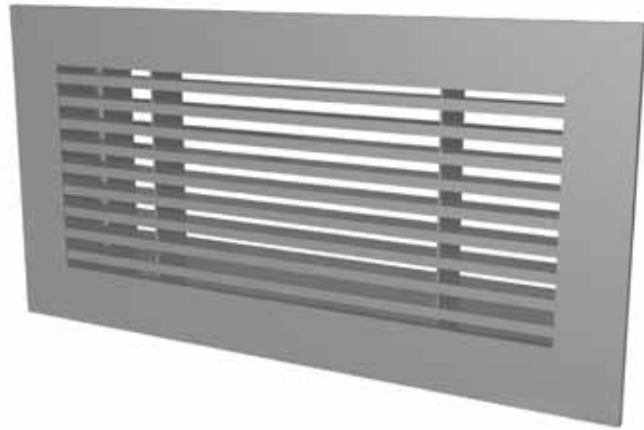

All dimensions are in inches.  
Finish is B15 Aluminum. Provided with spring clips for installation

**Model 530FF** - Steel, 45° Deflection Louvered Filter Grille

Size	CFM @ 500FPM Neck Velocity	List Price	
		Surface Mount	T Bar Mount
12 x 12	439	\$93.	--
24 x 12	908	131.	--
16 x 16	808	126.	--
18 x 18	1033	137.	--
24 x 18	1393	146.	--
20 x 20	1287	144.	\$147.
44 x 20	2878	--	263.
24 x 24	1857	171.	--



All dimensions are in inches. Finish is B12 White.  
Note: Filters are not included (Filter Rack is 1")

**Model ATGBF** - Aluminum, Flat Border Door Transfer Grille with Countersunk Screw Holes

Size	CFM @ 500FPM Neck Velocity	List Price
12 x 12	435	\$118.
18 x 12	668	136.
24 x 12	901	153.
18 x 18	1026	189.
24 x 24	1867	304.



All dimensions are in inches. Finish is B15 Aluminum.  
Note: This model fits in a door between 1 5/8" - 2 1/2" wide. (Double Frame)

# RGD Product Cross Reference



METAL\*AIRE



TUTTLE & BAILEY

Price Industries	Metal*Aire	Nailor Industries	Titus	Krueger	Tuttle & Bailey
AMD	5000	6400	--	--	--
AMDEX	5000IV	6400IV	--	--	RC/ARC
LCMD	5200D	--	--	--	--
SMD	5500S	6500	TDC	SH	M
SMX	5500SIV	6500IV	TDV	SHV	--
SCD	5700/5800	RNS	TMS	1400	S1200
SPD	5750/5850	UNI	OMNI	PLQ	T1100
SPDHI	PHENOMENATOR	--	--	--	--
RCDE	3100	RNR	TMR	RM1	P3
PDF	7500/7550	4320/4325	PAS	6604	PP
PDC	7600	4320CB/4325CB	PCS	6504	PV
PDDR	7500R	4360/4365	PAR/PMR/PDR	6490/6690	PP
PFRF	SPRTB	4302	PXP/PXP-DF	6790	PTL
APF	PFTB	DFA	TRM	5HCF	SMF
520D	V4004SD	61DV/61DH	300R	880	T64
540	4004M	--	--	--	--
530	SRH	6145	350R	S80	T70
630	RH	5145	350F	S580	A70
80	CC5	51EC	50	EGC5	CRE500
LBPH	2000F	--	CT-PP-0	LFD	4000
530FF	SRHF	61FB45	350RLF1SS	S80H	T70DFB
ATG	DG	51DG	CT-700L	600A	A990
TBDI	PHPSI	57101	TBDI	PSTBSI	SVPS
SDS100	6600	5010	ML-39	1910	6000
SDG	4004SP-1	--	US300/FS	DMGU	--
VPD-HC	--	--	T3SQ	--	--
SDV5	TH	3001	DESV	LMHS	SDV

The information contained within this cross reference should be used as a "guide" when making product selections. Buckley will not be held responsible for any errors caused by its use.

## Single Duct Terminal Units

### Models Available:

- SDV5..... Bare VAV Box
- SEV5..... VAV Box, Electric Actuator and Thermostat
- SPV5..... VAV Box, Pneumatic Actuator and Controller

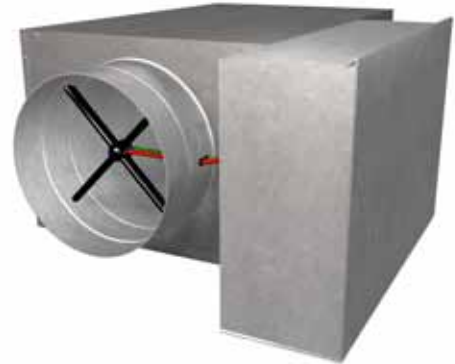

Size	CFM Range	Dimensional Data (W x H x L)		List Prices			
		VAV Box	Hot Water Coil	Model SDV5	Model SEV5	Model SPV5*	2 Row HW Coil Model HGCOIL <sup>2</sup>
6	66 - 450	12 x 8 x 20½	12 x 8 x 9	\$352.	\$782.	\$765.	\$288.
8	132 - 800	12 x 10 x 20½	12 x 10 x 9	416.	846.	829.	301.
10	221 - 1350	14 x 12½ x 20½	14 x 12½ x 9	440.	870.	853.	349.
12	304 - 2100	16 x 15 x 20½	16 x 15 x 9	473.	903.	886.	423.
14	439 - 3000	20 x 17½ x 23½	20 x 17½ x 9	579.	1009.	992.	572.
16	568 - 4000	24 x 18 x 23½	24 x 18 x 9	604.	1035.	1018.	632.

All dimensions are in inches.

**Note:** Asterisk (\*) denotes that this control enables the box to be field adjusted for normally open or normally closed damper position and can operate on either a direct acting or reversing acting thermostat (supplied by others).

All terminal boxes have closed cell insulation.

<sup>2</sup> Hot Water Coil in sleeve with slip joint connection for field mounting ¾" OD Sweat Connection and access door for inspection and maintenance.

## Modular Single Duct Terminal Units for Hospitals, Clean Rooms, & Laboratories

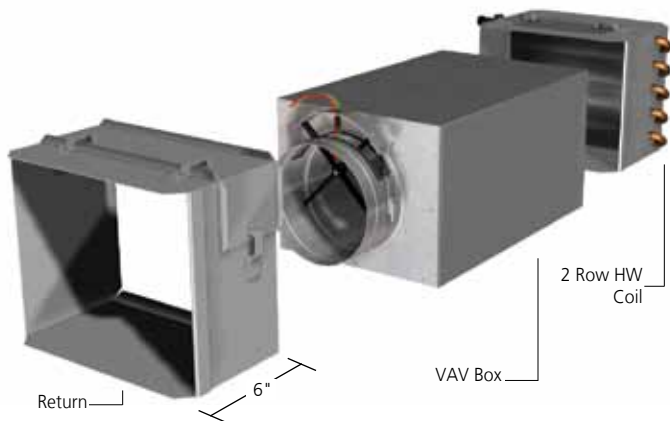

### Standard Construction Features

- Removable Inlet Sensors
- Solid Metal Liner
- 2 Row Hot Water Coil with Access Door
- Controls Enclosure (controls by others)

16 ga. Corrosion resistant metal valve with polyurethane gasket, 45° rotation. ½" solid steel shaft with self lubricating bearings and indicator slot to show damper position. Damper leakage is less than 2% at 3" w.g. inlet static pressure.

Size	Dimensional Data (W x H x L)				List Prices		
	VAV Box	Hot Water Coil	Inlet	Max CFM	VAV Box Model HGB	Return Model HGRET	2 Row HW Coil Model HGCOIL
6	12 x 8 x 20½	12 x 8 x 9	6	450	\$523.	\$409.	\$288.
8	12 x 10 x 20½	12 x 10 x 9	8	800	579.	437.	301.
10	14 x 12½ x 20½	14 x 12½ x 9	10	1350	623.	452.	349.
12	16 x 15 x 20½	16 x 15 x 9	12	2100	642.	507.	423.

All dimensions are in inches.

## VAV Accessories and Replacement Parts

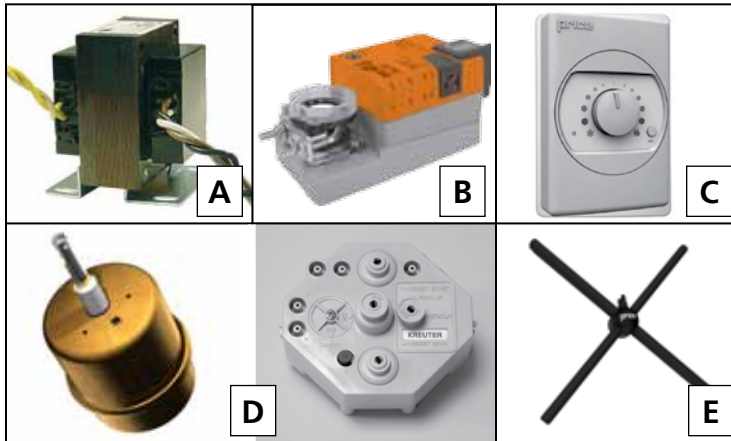

Key	Model #	Description	List Price
A	TRANSFORMERDUALV	Transformer 120V/277V/24V	\$46.
B	LMB24-3-T	24 Volt Electric Actuator	163.
C	TSTATS	24 Volt Electric Thermostat	267.
D	PNEUMATICCONTROLS	Pneumatic Actuator and Controller	413.
E	INLETSENSOR*	Airflow Inlet Sensor	69.

\* Must specify inlet size: 6, 8, 10, 12, 14, or 16".

## Model VPD-HC - Varitherm VAV Heating and Cooling Diffuser with Round Neck



The Price Varitherm® self-modulating diffuser series is designed to provide accurate personal VAV control, while being easy to install, operate, and maintain. Thermal sensors, mounted just above the plaque, sense the room temperature and modulate a damper according to the supply air temperature and load in the room -- all done mechanically so there is no requirement for power or wiring.

### Features

- Ease of Installation
- Independent Heating & Cooling Temperature Set Points
- Minimum Airflow Adjustment
- Automatic Heating / Cooling Changeover
- Room Side Balancing Mode Adjustment
- Incorporated Forced Open Mode
- No Turn Down Effects

Size	CFM @ 500FPM Neck Velocity	List Price
6	98	\$916.
8	174	916.
10	273	916.
12	393	916.

All dimensions are in inches.